





# gala

**Reference** G3989400  
**Description** Basin mixer  
**Collection** GADEA



## TECHNICAL SPECIFICATIONS

-  Single lever mixer with cold start
  -  Flow restrictor to 5 l/min included
  -  Produced with recycled materials
  -  The alloy used to produce it is included in the "European Positive List" (no migration of hazardous materials to water)
  -  G-Last chrome technology: high resistance against scratches
- Ceramic discs cartridge  $\varnothing 35$  mm
- 3/8" flexible connection hoses included
- Installation with up-down valve

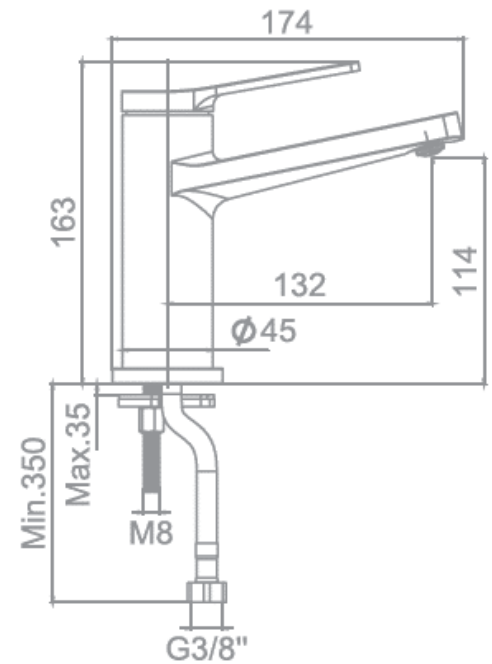

## FLOW RATE

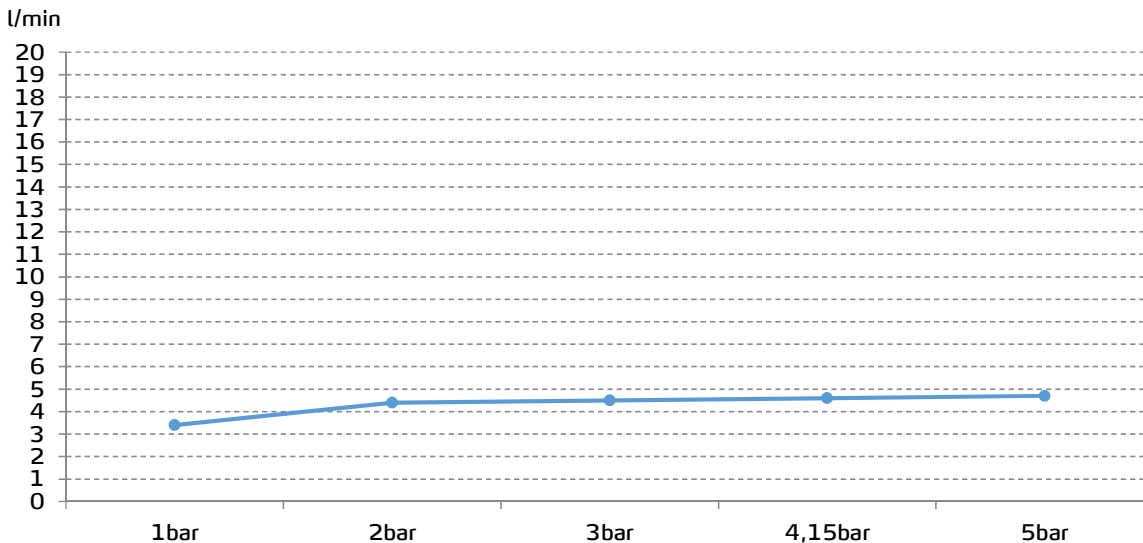

Data measured in maximum flow position with mixed water