









gala

Reference G3997000
Description Basin mixer
Collection LORA



TECHNICAL SPECIFICATIONS

-  Single lever mixer with cold start
 -  Flow restrictor to 5 l/min included
 -  AENOR certification
 -  Contributes to obtaining BREEAM, LEED and VERDE certifications through its sustainable use of water
 -  Produced with recycled materials
 -  The alloy used to produce it is included in the "European Positive List" (no migration of hazardous materials to water)
 -  Low noise level
 -  G-Last chrome technology: high resistance against scratches
- Ceramic discs cartridge $\varnothing 35$ mm
- 3/8" flexible connection hoses included
- Installation with up-down valve

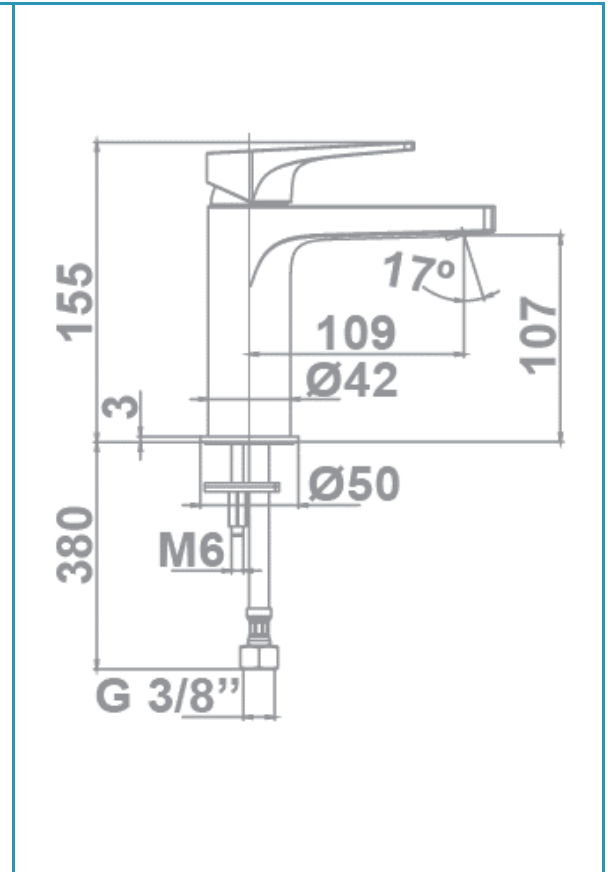

FLOW RATE

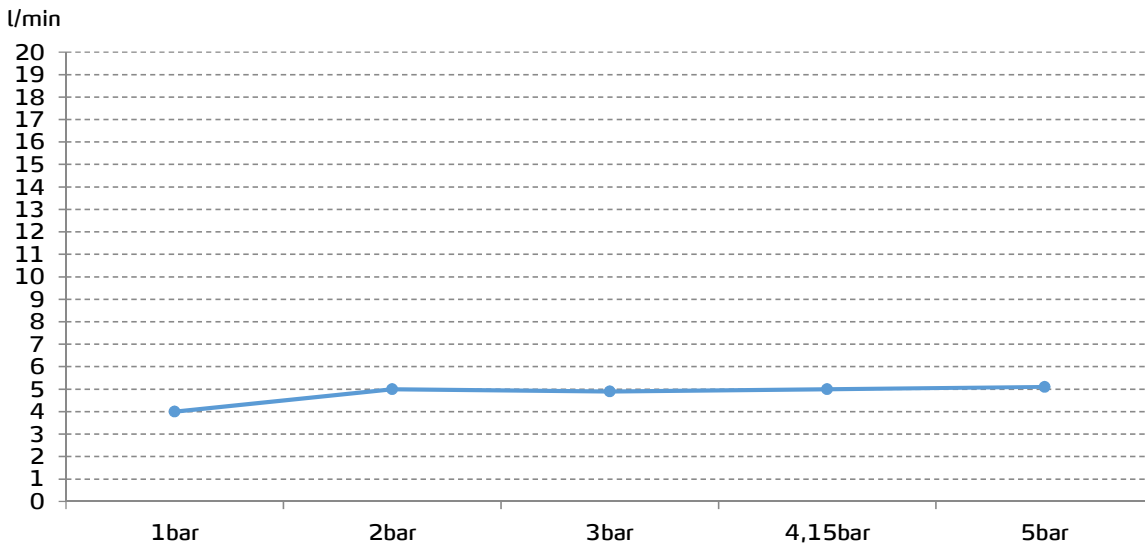

Data measured in maximum flow position with mixed water