









# gala

**Referencia** G3997900  
**Descripción** Monomando de cocina  
**Serie** LORA



## CARACTERÍSTICAS TÉCNICAS

-  Incorpora limitador de caudal a 5 l/min
  -  Caño giratorio
  -  Certificación AENOR
  -  Contribuye a la obtención de las certificaciones BREEAM, LEED y VERDE por su ahorro en el consumo de agua
  -  Fabricado utilizando materiales reciclados
  -  Fabricado con aleaciones incluidas en la "European Positive List" (para la no migración de materiales peligrosos al agua)
  -  Bajo nivel de ruido
  -  Tecnología de cromado G-Last: alta resistencia al rayado
- Cartucho de discos cerámicos de  $\varnothing 35$  mm
- Incluye enlaces de alimentación flexible de 3/8"

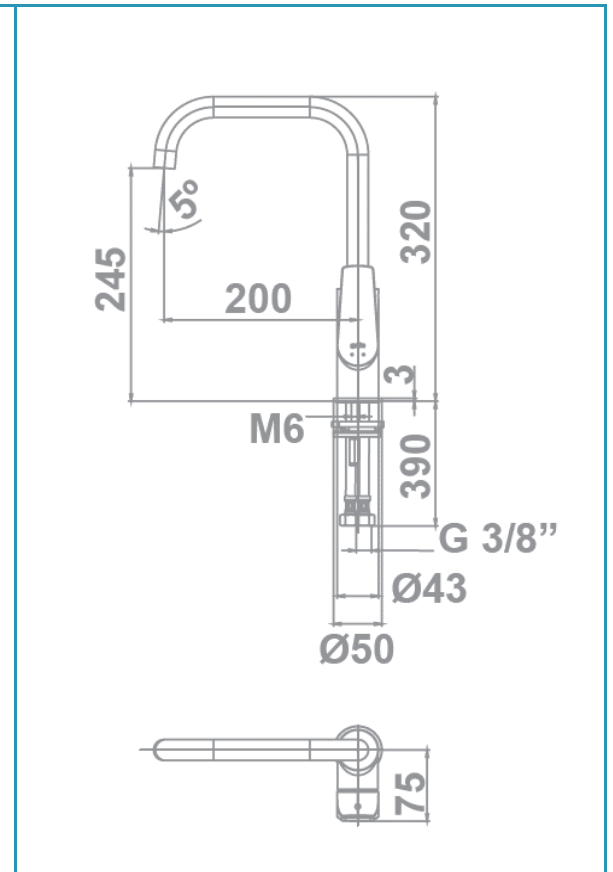

## CURVA DE CAUDALES

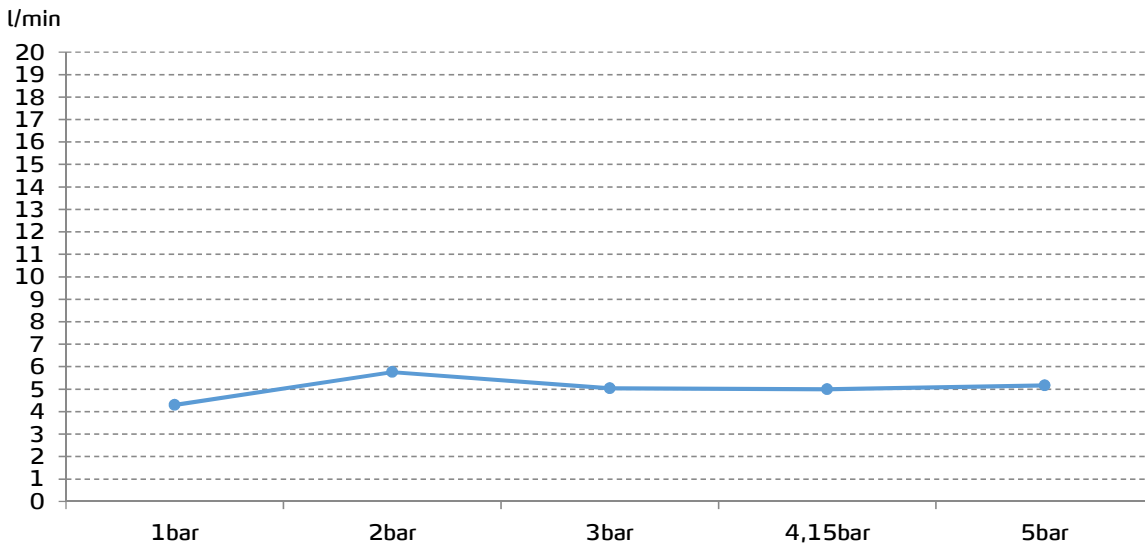

Datos medidos en posición de mezcla y máxima apertura