

**gala**



**GALA·INNOVA<sup>®</sup>**  
SHOWER TOILET

**GALA·INNOVA**<sup>®</sup>  
SHOWER TOILET



**Step into a  
new dimension**

**GALA·INNOVA**<sup>®</sup>  
SHOWER TOILET



Innovative  
Intelligent  
Intuitive  
Indispensable

# Discover the power of water

A new generation of WCs in which technology and water take center stage, bringing hygiene and comfort to a new dimension.



## Functionality, design and accessible technology

### More intuitive

You won't believe how easy it is. With Gala Innova you will enjoy a perfect experience from day one.





### More hygiene

There is nothing so natural, so simple and yet so revolutionary as water to achieve outstanding intimate hygiene.

### More comfort

Easily customizable settings to adapt to the preferences of every user.



OPEN  
THE DOOR  
TO TECHNOLOGY







### Control panel

A simple side panel activates the main washing and drying functions of the WC.



### Presence sensor

An infrared sensor prevents the WC from activating if it doesn't detect any presence on the seat.



### Rimless +

Gala Innova is a rimless WC. Water flows from the rear, homogeneously reaching the entire bowl.



### Night light

A LED light located at the rear end of the seat guides users to the WC, without having to turn on the bathroom lights.

4 functions:

**Standard:** it activates when the cover is lifted and turns off one minute after detecting any presence.

**Night light:** The light remains on for 8 hours at night.

**Standard with night light:** The light remains on for 8 hours and it works in Standard mode for the remaining 16 hours.

**Off:** The LED light is always off when this function is chosen.



### Design and comfort

Inspired by minimalism, Gala Innova adapts to all kinds of interior designs, ensuring maximum comfort.



### Soft-close seat

The seat features soft-close hinges and therefore it closes silently, avoiding involuntary blows.



### Removable seat

In order to make cleaning easier, the seat and cover can be fully removed with a simple gesture.



### Hidden connections

To obtain a cleaner design, the water and power connections are hidden behind the WC. Its installation only requires a common water inlet.

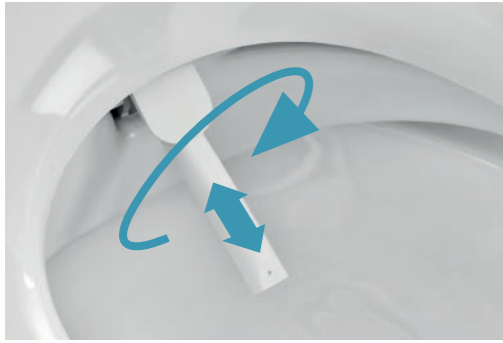

#### Detachable nozzle

The nozzle can be easily detached, in order to clean it thoroughly.



#### Self-cleaning nozzle

The retractable nozzle cleans itself before and after each use to ensure maximum hygiene.



#### Adjustable position

The nozzle has five different positions so as to provide greater precision and comfort.

# DESIGN AND ERGONOMICS



# FEATURES



# More features

An extraordinary WC with an outstanding performance. Gala Innova moves forward in innovation and development to offer the most comprehensive functionality.

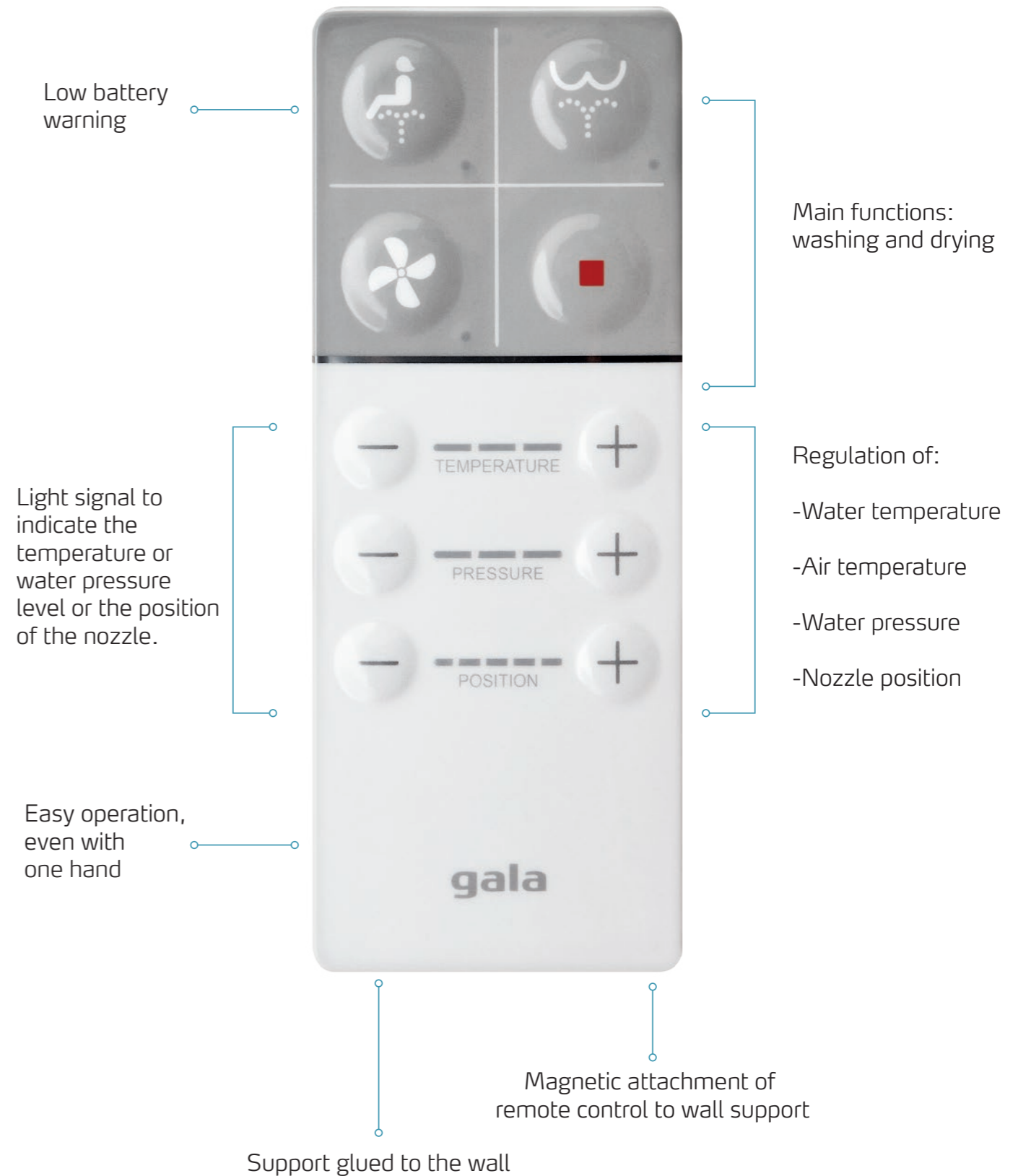

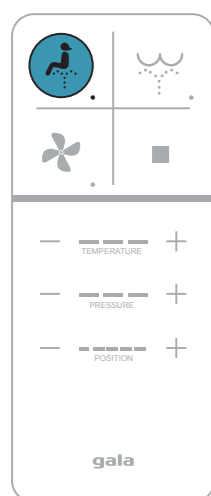

### Front wash

The nozzle is activated in the front position.  
Adjustable settings:  
- Water temperature  
- Water pressure  
- Nozzle position  
- Oscillating movement of nozzle

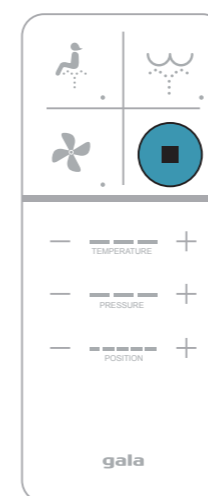

### Stop

It stops any active function.

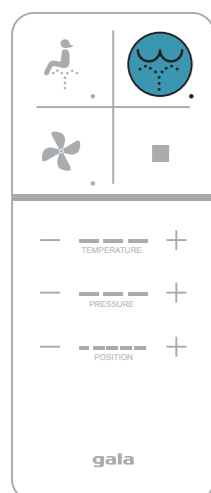

### Rear wash

The nozzle is activated in the rear position.  
Adjustable settings:  
- Water temperature  
- Water pressure  
- Nozzle position  
- Oscillating movement of nozzle

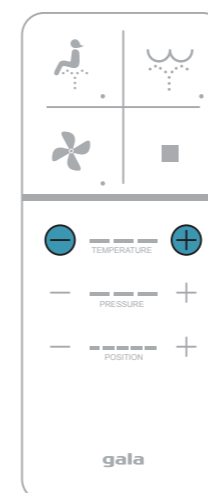

### Water temperature

The water temperature has four adjustment levels:

- Ambient: no LEDs light up
- Low (33°): one LED lights up
- Medium (36°): two LEDs light up
- High (39°): three LEDs light up

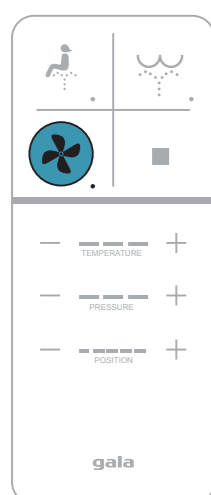

### Drying

The drying function is activated.  
- Adjustable air temperature

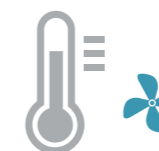
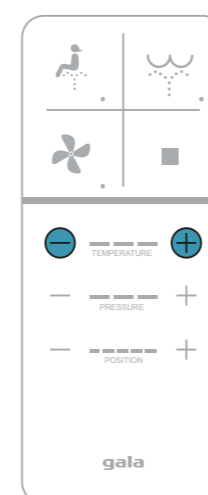

### Air temperature

The air temperature has four adjustment levels:

- Ambient: no LEDs light up
- Low: one LED lights up
- Medium: two LEDs light up
- High: three LEDs light up

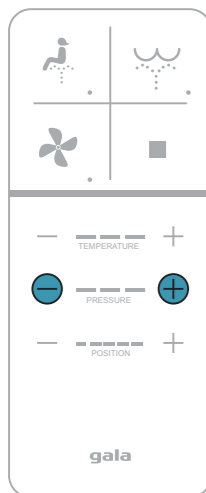

### Water pressure

The water pressure has three adjustment levels.

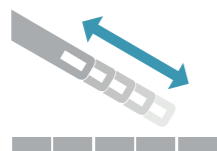
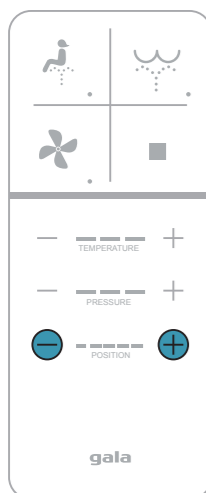

### Nozzle position

The nozzle has 5 different positions to meet the needs of every user. By default, it starts in the middle position, moving two positions to the front and two to the rear.

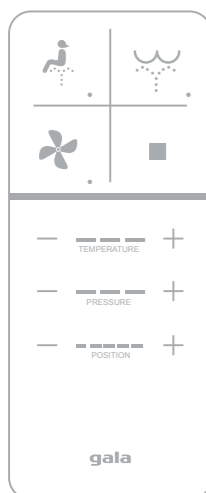

### Low battery

When the battery is low, all LED lights in the remote control blink at the same time.



## Technical specifications

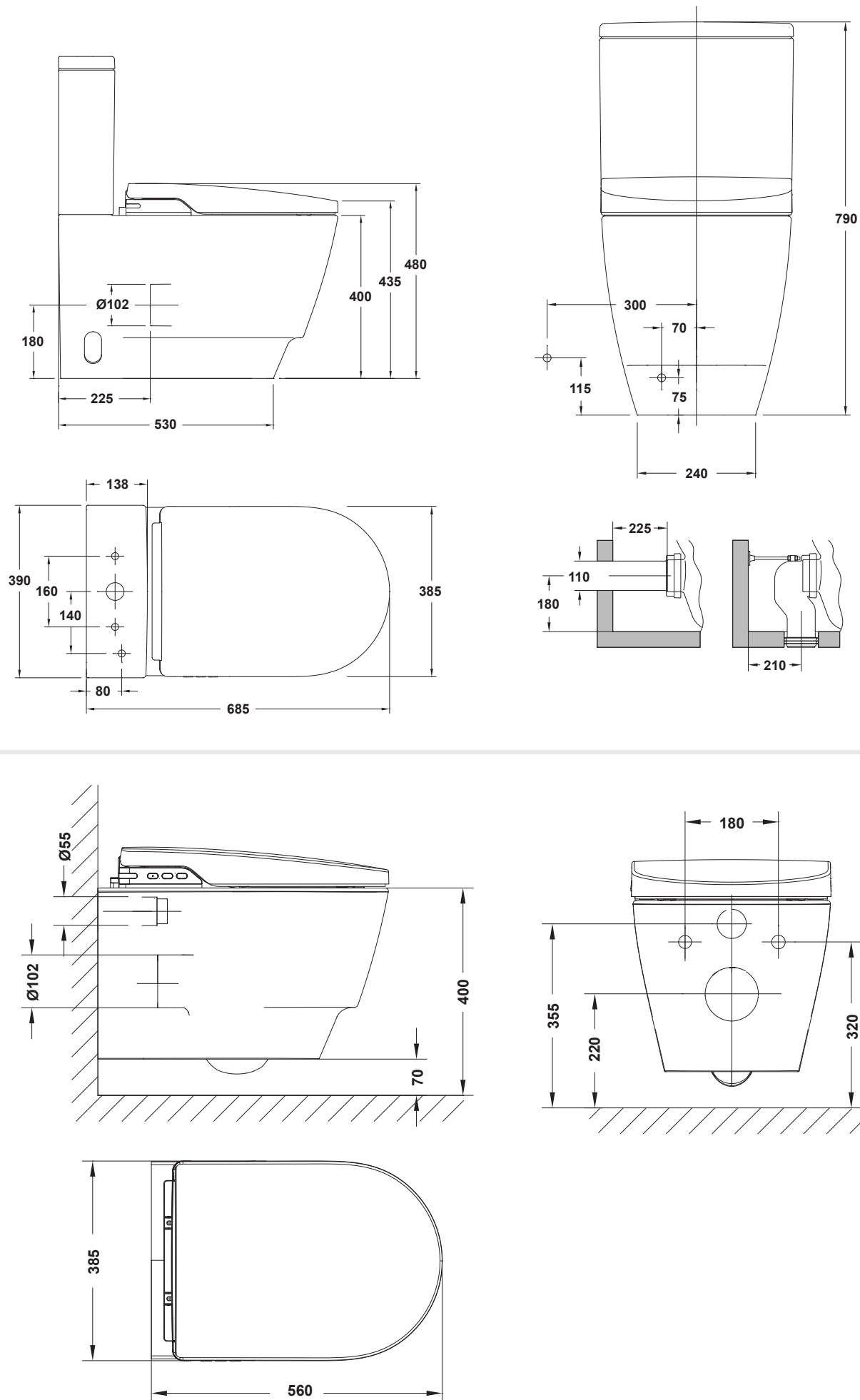

## Installation



### Full Frame Gala Innova

Installation system for wall-hung WC in dry walls

Compact cistern and dual push-button mechanism 6/3, 4,5/3 and 4/2 liters.

Minimum depth horizontal outlet: 80 mm.

Minimum depth vertical outlet: 107/125 mm (DN90 / DN100).

Conversion bend  $\varnothing 90$  or 110 mm.

Only compatible with Eon push-buttons.

Installation system for self-supporting wall-hung WC.

Flexible inlet hose and corrugated pipe for Shower toilets included.

Installation system for floorstanding WC in dry and wet walls.

Minimum depth: 80 mm.



### One single water inlet

Gala Innova only requires one water inlet for its installation. The system itself separates and distributes water towards the cistern or towards the nozzle.

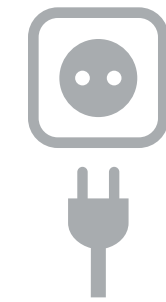

### Compatible with the mains

The WC does not require a special electric installation, it is compatible with the conventional power supply.



**Certificates**  
CE/ RoHS  
WRAS  
KTW (W270)



### Easy installation of the remote control

The support for the remote control can be easily installed using screws or adhesive.

### Safety regulations

Norms for vitreous china: UNE 67001, EN 997

Safety for domestic use: IEC 60335-1, IEC 60335-2, IEC 60695-10-2

Electromagnetic compatibility: IEC 61000-6-2, IEC 61000-6-4

Protection against drinking water contamination: EN 1717, EN 13077





JOIN  
THE REVOLUTION

Colours are illustrative and may differ from reality due to their printing on paper. Due to technical or commercial reasons, GALA reserves the right to modify the materials and specifications of the models at any time, giving prior written notice.



**galabaño**

**Cerámicas Gala, S.A.**

Crta. Madrid-Irún km.244

Apartado 293 · 09080 Burgos

Tel. +34 947 47 41 00 · Fax +34 947 47 41 03

Email: [general@gala.es](mailto:general@gala.es)

[www.gala.es](http://www.gala.es)