



## EMMA SQUARE

**Lavamanos 50x35 cm.**

**REF: 27080**

Lavamanos EMMA SQUARE compact de 50 cm. A pesar de su tamaño reducido, se puede instalar con pedestal, semipedestal, mural o sobre-encimera.

El precio del lavabo no incluye grifo.

**PVP: 113,0 €**

REF. 27080

### COLORES / ACABADOS

01  
Blanco

### COMPLEMENTOS



### ARTÍCULOS

Ref.	Producto/Conjunto	Medidas	€/u
27080	Lavamanos con juego de fijación	50 x 35 cm	<b>113,0 €</b>
<b>Opciones</b>			
27095	Lavamanos con rebosadero y juego de fijación	50 x 25 cm	<b>108,0 €</b>
27085	Lavamanos con rebosadero y juego de fijación	42 x 32 cm	<b>109,0 €</b>
27075	Lavamanos con juego de fijación	48 x 37,5 cm	<b>163,0 €</b>

### INFORMACIÓN DE PRODUCTO

#### Características

Lavamanos de 50 x 35 cm. Con juego de fijación. / 13 kg./ 24 unidades palet. Posibilidad de instalación con pedestal, semipedestal, mural o sobre-encimera. Combinable con muebles Emma.

#### Información de utilidad

Los lavabos Emma Square se suministran con embellecedor para rebosadero.

#### Garantía

Los productos Gala están garantizados ante cualquier defecto de fabricación, desde la fecha de adquisición del producto, siempre y cuando la instalación haya sido efectuada de acuerdo con las instrucciones de instalación de Gala y, aplicando la normativa en vigor para instalaciones eléctricas y de saneamiento, por personal autorizado. El periodo de garantía para porcelana sanitaria es de 5 años.

#### Instalación

[Ver manuales de instalación](#)

#### Certificaciones

La calidad en Gala es una constante para garantizar las características técnicas, estéticas y las prestaciones de nuestros productos. Ver certificados de calidad del producto.

#### Mantenimiento

La limpieza se realizará preferentemente con detergente líquido y un cepillo o esponja. No rasar con cuchillas o estropajos de acero. Cada seis meses es recomendable comprobar las juntas de los desagües y verificar que éstos no gotean.

### AMBIENTE





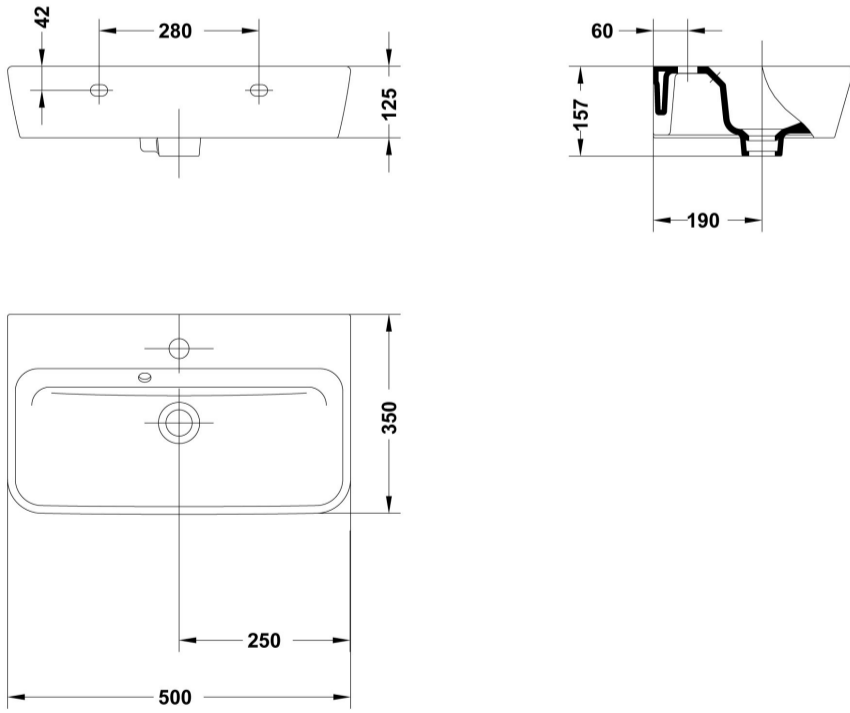



















DIBUJOS TÉCNICOS





## DESCARGAS

### 2D

	84.76 KB	 Lavamanos 50x35 cm. - Técnico (.AI)
	63.79 KB	 Lavamanos 50x35 cm. - Técnico (.DWG)
	443.59 KB	 Lavamanos 50x35 cm. - Técnico (.DXF)
	94.66 KB	 Lavamanos 50x35 cm. - Técnico (.PDF)
	31.16 KB	 Lavamanos 50x35 cm. - Alzado (.DWG)
	27.95 KB	 Lavamanos 50x35 cm. - Alzado (.DXF)
	31.24 KB	 Lavamanos 50x35 cm. - Lateral (.DWG)
	28.26 KB	 Lavamanos 50x35 cm. - Lateral (.DXF)
	34.82 KB	 Lavamanos 50x35 cm. - Planta (.DWG)
	40.68 KB	 Lavamanos 50x35 cm. - Planta (.DXF)
	31.34 KB	 Lavamanos 50x35 cm. - Alzado (.DWG)
	28.23 KB	 Lavamanos 50x35 cm. - Alzado (.DXF)
	31.11 KB	 Lavamanos 50x35 cm. - Lateral (.DWG)
	27.92 KB	 Lavamanos 50x35 cm. - Lateral (.DXF)
	34.84 KB	 Lavamanos 50x35 cm. - Planta (.DWG)
	147.11 KB	 Lavamanos 50x35 cm. - Planta (.DXF)
	31.63 KB	 Lavamanos 50x35 cm. - Alzado (.DWG)
	29.58 KB	 Lavamanos 50x35 cm. - Alzado (.DXF)
	31.1 KB	 Lavamanos 50x35 cm. - Lateral (.DWG)
	28.3 KB	 Lavamanos 50x35 cm. - Lateral (.DXF)
	34.79 KB	 Lavamanos 50x35 cm. - Planta (.DWG)
	40.67 KB	 Lavamanos 50x35 cm. - Planta (.DXF)

### 3D

	1.35 MB	 Lavamanos 50x35 cm. - 3D (.DWG)
---	---------	---

**bimobject**

	ArchiCAD	
	Revit	