



## EMMA SQUARE

**Lavamanos 50x35 cm.**

**REF: 27080**

Lavamanos compact de 50 cm. A pesar de su tamaño reducido, se puede instalar con pedestal, semipedestal, mural o sobre-encimera.

Grifería no incluida.

**PVP: 113,0 €**

REF. 27080

### COLORES / ACABADOS

01  
Blanco

### ARTÍCULOS

Ref.	Producto/Conjunto	Medidas	€/u
27080	Lavamanos con juego de fijación	50 x 35 cm	113,0 €
<b>Opciones</b>			
27432	Semipedestal con juego de fijación		79,0 €
27430	Pedestal		88,5 €

### INFORMACIÓN DE PRODUCTO

#### Características

Lavamanos Emma Square de 50 x 35 cm. con rebosadero y juego de fijación. / 13 kg. / 32 unidades palet. Lavabo para instalación sobre-encimera, mural o combinable con muebles Emma.

#### Información de utilidad

Los lavabos Emma Square se suministran con embellecedor para rebosadero.

#### Garantía

Los productos Gala estan garantizados ante cualquier defecto de fabricación, desde la fecha de adquisición del producto, siempre y cuando la instalación haya sido efectuada de acuerdo con las instrucciones de instalación de Gala y, aplicando la normativa en vigor para instalaciones eléctricas y de saneamiento, por personal autorizado. El periodo de garantía para porcelana sanitaria es de 5 años.

#### Instalación

[Ver manuales de instalación](#)

#### Certificaciones

La calidad en Gala es una constante para garantizar las características técnicas, estéticas y las prestaciones de nuestros productos. Ver certificados de calidad del producto.

#### Mantenimiento

La limpieza se realizará preferentemente con detergente líquido y un cepillo o esponja. No rasar con cuchillas o estropajos de acero. Cada seis meses es recomendable comprobar las juntas de los desagües y verificar que éstos no gotean.

### COMPLEMENTOS



### SUGERENCIAS



### AMBIENTE





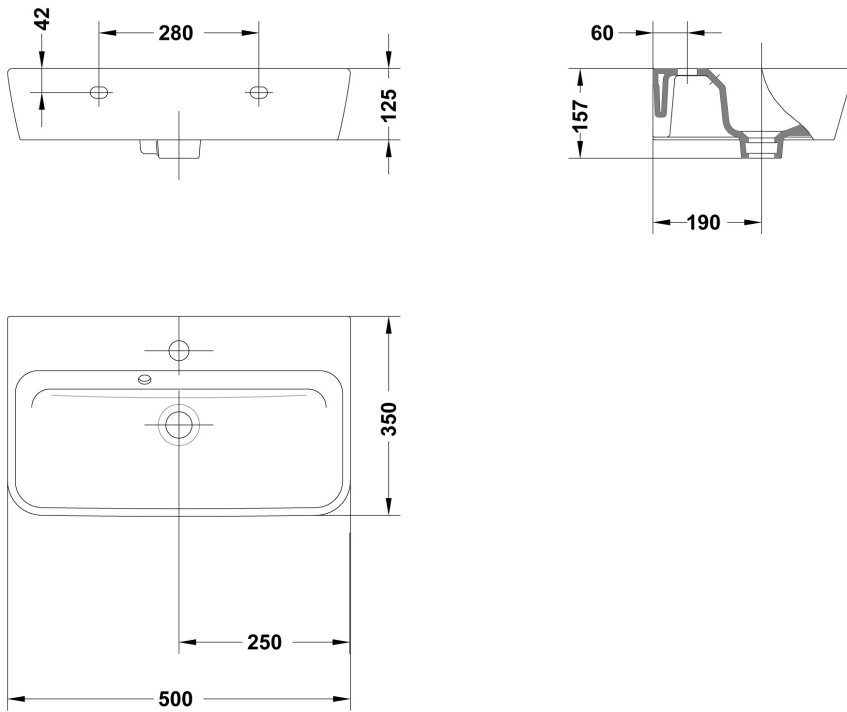



DIBUJOS TÉCNICOS





---

## DESCARGAS





### 2D

	78.36 KB	 Lavamanos 50x35 cm. - Técnico (.AI)
	66.97 KB	 Lavamanos 50x35 cm. - Técnico (.DWG)
	447.17 KB	 Lavamanos 50x35 cm. - Técnico (.DXF)
	91.35 KB	 Lavamanos 50x35 cm. - Técnico (.PDF)
	31.16 KB	 Lavamanos 50x35 cm. - Alzado (.DWG)
	27.95 KB	 Lavamanos 50x35 cm. - Alzado (.DXF)
	31.24 KB	 Lavamanos 50x35 cm. - Lateral (.DWG)
	28.26 KB	 Lavamanos 50x35 cm. - Lateral (.DXF)
	34.82 KB	 Lavamanos 50x35 cm. - Planta (.DWG)
	40.68 KB	 Lavamanos 50x35 cm. - Planta (.DXF)
	31.34 KB	 Lavamanos 50x35 cm. - Alzado (.DWG)
	28.23 KB	 Lavamanos 50x35 cm. - Alzado (.DXF)
	31.11 KB	 Lavamanos 50x35 cm. - Lateral (.DWG)
	27.92 KB	 Lavamanos 50x35 cm. - Lateral (.DXF)
	34.84 KB	 Lavamanos 50x35 cm. - Planta (.DWG)
	147.11 KB	 Lavamanos 50x35 cm. - Planta (.DXF)
	31.63 KB	 Lavamanos 50x35 cm. - Alzado (.DWG)
	29.58 KB	 Lavamanos 50x35 cm. - Alzado (.DXF)
	31.1 KB	 Lavamanos 50x35 cm. - Lateral (.DWG)
	28.3 KB	 Lavamanos 50x35 cm. - Lateral (.DXF)
	34.79 KB	 Lavamanos 50x35 cm. - Planta (.DWG)
	40.67 KB	 Lavamanos 50x35 cm. - Planta (.DXF)

### 3D

	1.35 MB	 Lavamanos 50x35 cm. - 3D (.DWG)
---	---------	---

**bimobject**

	ArchiCAD	
	Revit	

---

## VÍDEOS